

bühler

farm king

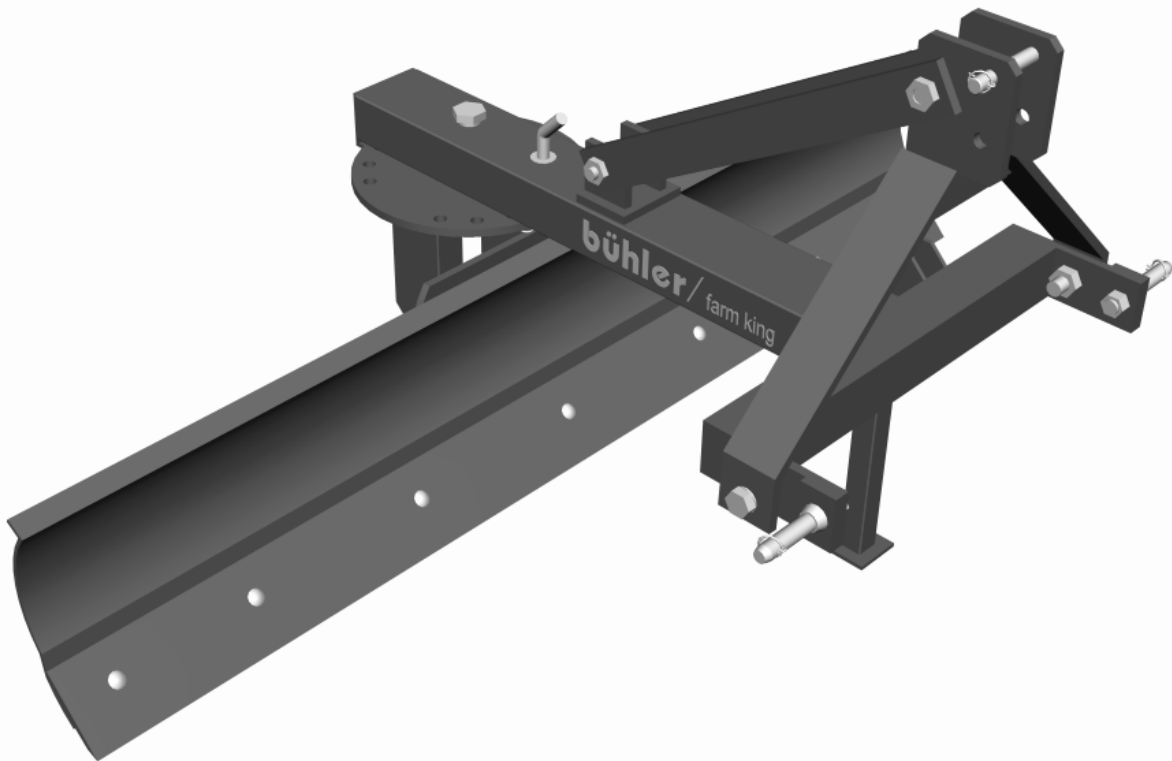

45 Series Rear Blade

Operator's and Parts Manual
FK343

2007-1

TABLE OF CONTENTS

DESCRIPTION	PAGE NUMBER
Warranty	1
Rear Blade Drawing	2
45 Series Rear Blade Parts List	3
Bundle Numbers	4

WARRANTY POLICY

Buhler Manufacturing products are warranted for a period of twelve (12) months (90 days for commercial application) from original date of purchase, by original purchaser, to be free from defects in material and workmanship under correct, normal agricultural use and proper applications.

Buhler Manufacturing's obligations under this warranty shall be limited to the repair or exchange, at Buhler Manufacturing's option, of any Buhler Manufacturing product or part which proves to be defective as provided. Buhler Manufacturing reserves the right to either inspect the product at the buyer's location or have it returned to the factory for inspection.

The above warranty does not extend to goods damaged or subject to accident, abuse or misuse after shipment from Buhler Manufacturing's factory, nor to goods altered or repaired by anyone other than an authorized Buhler Manufacturing representative.

Buhler Manufacturing makes no Express Warranties other than those, which are specifically described. Any description of goods, including any references and specifications in catalogues, circulars and other written material published, is for the sole purpose of identifying goods and shall conform to such descriptions. Any sample or model is for illustrative purposes only and does not create an Express Warranty that the goods conform to sample or model shown.

The purchaser is solely responsible for determining suitability of goods sold. This warranty is expressly in lieu of all other warranties expressed or implied. Buhler Manufacturing will in no event be liable for any incidental or consequential damages whatsoever. Nor for any sum in excess of the price received for the goods for which liability is claimed.

WARRANTY CLAIMS:

Warranty requests must be prepared on Buhler Manufacturing Warranty Claim Forms with all requested information properly completed. Warranty Claims must be submitted within a thirty (30) day period from date of failure repair.

WARRANTY LABOR:

Any labor subject to warranty **must** be authorized by Buhler Manufacturing. The labor rate for replacing defective parts, where applicable, will be credited at 100% of the dealer's posted shop rate. Defective parts will receive an extra 10% discount to assist with freight or other incidental costs.

GOVERNMENT LEGISLATION:

Warranty terms and conditions are subject to Provincial or State legislation.

IMPORTANT FACTS:

Buckets and Bucket Tines Carry No Warranty
Bent Spears Carry No Warranty
Snowblower Fan Shafts Carry No Warranty
Mower Blades Carry No Warranty
Portable Auger Parts Have Two (2) Year Warranty
Loader Parts Have Two (2) Year Warranty

IMPORTANT NOTE: This warranty does not apply to rentals

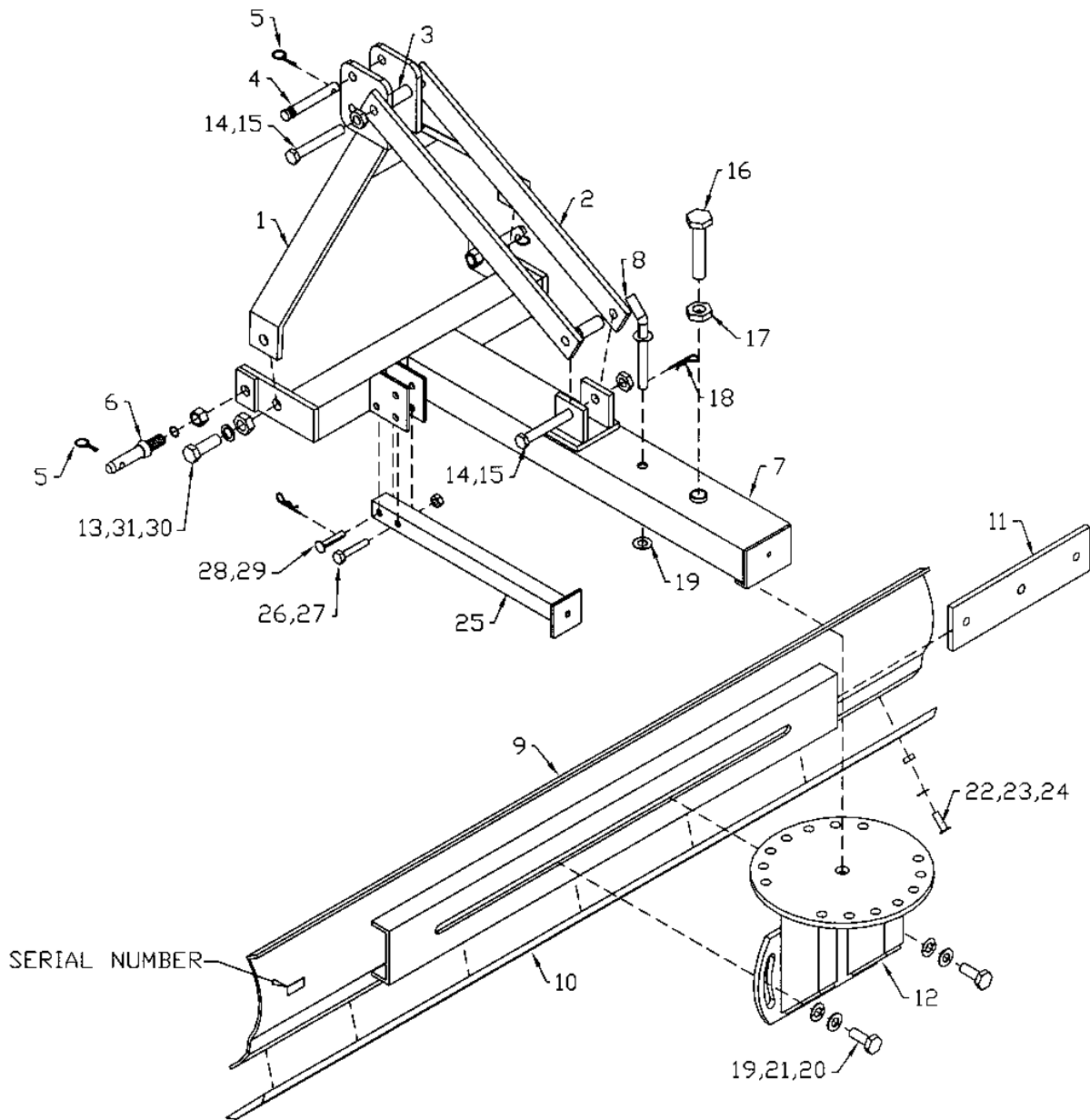

RB-01

WHEN ORDERING PARTS

Always give your dealer the Model, Color and Serial Number of your machine to assist him in ordering and obtaining the correct parts. Use the exploded view and tabular listing of the area of interest to exactly identify the required part.

45 SERIES REAR BLADE

ITEM	PART #	DESCRIPTION
1	F0351	Hitch Weld't
2	906768	Hitch Brace
3	906770	Spacer 1" O.D. x 2 1/4" Lg
4	965807	Top Link Pin (Cat.1)
5	965911	Linch Pin (7/16")
6	965809	Lift Arm Pin W/ Nut & Washer (Cat.1)
7	906767	T-Frame Weld't
8	967535	Turntable Pin
9	967536	60" Blade Weld't
	967537	72" Blade Weld't
	967538	84" Blade Weld't
10	967520	60" Cutting Edge
	967521	72" Cutting Edge
	967522	84" Cutting Edge
11	967542	Adjustment Plate (15"L)
12	967543	Turntable Weld't
13	81722	7/8" Hex Nut (pl)
14	811751	3/4" X 5" Hex Bolt (pl)
15	812365	3/4" Lock Nut (pl)
16	967527	1" X 5" Hex Bolt (pl)
17	967148	1" Lock Nut (pl)
18	12779	#9 Hair Pin Clip (pl)
19	84050	3/4" S.A.E. Flat Washer (pl)
20	84467	3/4" X 2" Hex Bolt (pl)
21	81701	3/4" Lock Washer (pl)
22	967524	1/2" X 1 1/2" Plow Bolt (pl)
23	81637	1/2" Lock Washer (pl)
24	81636	1/2" Hex Nut (pl)
25	902277	Stand Weld't
26	81626	1/2" X 2 3/4" Hex Bolt (pl)
27	812364	1/2" Lock Nut (pl)
28	901435	1/2" X 2 1/2" Clevis Pin (pl)
29	961012	#16 Hair Pin Clip (pl)
30	966527	7/8" x 2 1/2" Hex Bolt (pl)
31	81723	7/8" Lock Washer (pl)

BUNDLE NUMBERS

QUANTITY	BUNDLE NO.	DESCRIPTION
60" REAR BLADE: C60SS		
1	F0351	Hitch Weldment
1	F0362	T-Frame Bundle
1	F6505	Blade Assembly
1	F0363	Turntable
72" REAR BLADE: C72SS		
1	F0351	Hitch Weldment
1	F0362	T-Frame Bundle
1	F6506	Blade Assembly
1	F0363	Turntable
84" REAR BLADE: C84SS		
1	F0351	Hitch Weldment
1	F0362	T-Frame Bundle
1	F6507	Blade Assembly
1	F0363	Turntable

NOTES

DIVISION LOCATIONS

Farm King Division
301 Mountain Street S.
Morden, MB R6M 1X7
Ph.: (204) 822-4467
Fax: (204) 822-6348

Allied Division
1201 Regent Ave. W.
Box 1003
Winnipeg, MB R2C 3B2
Ph.: (204) 661-8711
Fax: (204) 654-2503

Inland Division
675 Washington Ave.
Winnipeg, MB R2K 1M4
Ph: (204) 667-7854
Fax: (204) 669-2599

B.I.I. Division
1330 43rd Street N.W.
Fargo, ND 58102
Ph: (701) 282-7014
Fax: (701) 282-5865

CANADIAN WAREHOUSES

B.C., Abbotsford
(604) 864-2665

AB, Edmonton
(403) 962-6991

SK, Regina
(306) 781-2300

ON, Woodstock
(519) 539-0435

ON, Jasper
(613) 283-1758

QC, Dorion
(450) 455-4840

U.S. WAREHOUSES

AR, West Memphis
(870) 732-3132

GA, Stone Mountain
(770) 908-9439

IA, Lakeview
(712) 657-8585

ID, Meridian
(208) 887-6006

IN, Clarksville
(812) 284-3376

KS, Wichita
(316) 265-9577

MN, Lakeville
(952) 469-5267

MT, Billings
(406) 248-7771

ND, Bismarck
(701) 223-1886

ND, Fargo
(701) 282-7003

NY, Syracuse
(315) 463-5276

OH, Youngstown
(330) 793-0862

OR, Portland
(503) 234-0378

SD, Huron
(605) 352-8616

TX, Houston
(713) 928-2632

UT, Salt Lake City
(801) 972-4321

WI, Portage
(608) 742-1370

OFFSHORE WAREHOUSES

Burando Hill
Katanning
W. Australia
011-618-98-214422

Chihuahua, Mexico
011-52-158-90306

John Kerr Equipment Ltd.
Wilcoxholm Farm
Linlithgow, W. Lothian
Scotland
011-441-506-842280

Skovde, Sweden
011-46-500-452651

Naestved, Denmark
011-45-557-29511

bühler

Buhler Manufacturing "a partnership"

301 Mountain Street S.
Morden MB.
R6M 1X7
Ph.: (204) 822-4467
Fax: (204) 822-6348
www.buhler.com